

MULTI V™ S

Highlight

- Air cooled VRF Heat pump & Heat Recovery
- 12.1 ~ 33.6kW (Cooling capacity based)
- Both 1Ø, 220 ~ 240V, 50Hz and 3Ø, 380 ~ 415V, 50Hz
- Side discharge outdoor unit
- Includes the industry's first single phase Heat Recovery system
- Includes the industry's first R32 side discharge

Energy savings	Reliability	Convenience

How does it work?

Available in Heat Pump and Heat Recovery Models

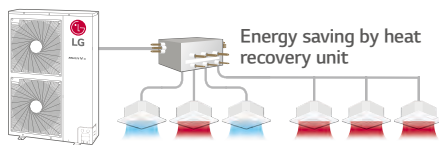

Combination of Cooling, Heating and Hot Water Solution

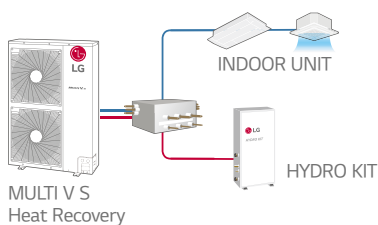

※ Heat Pump and Recovery are separated models.



※ Only applies to Multi V S with R410A refrigerant.

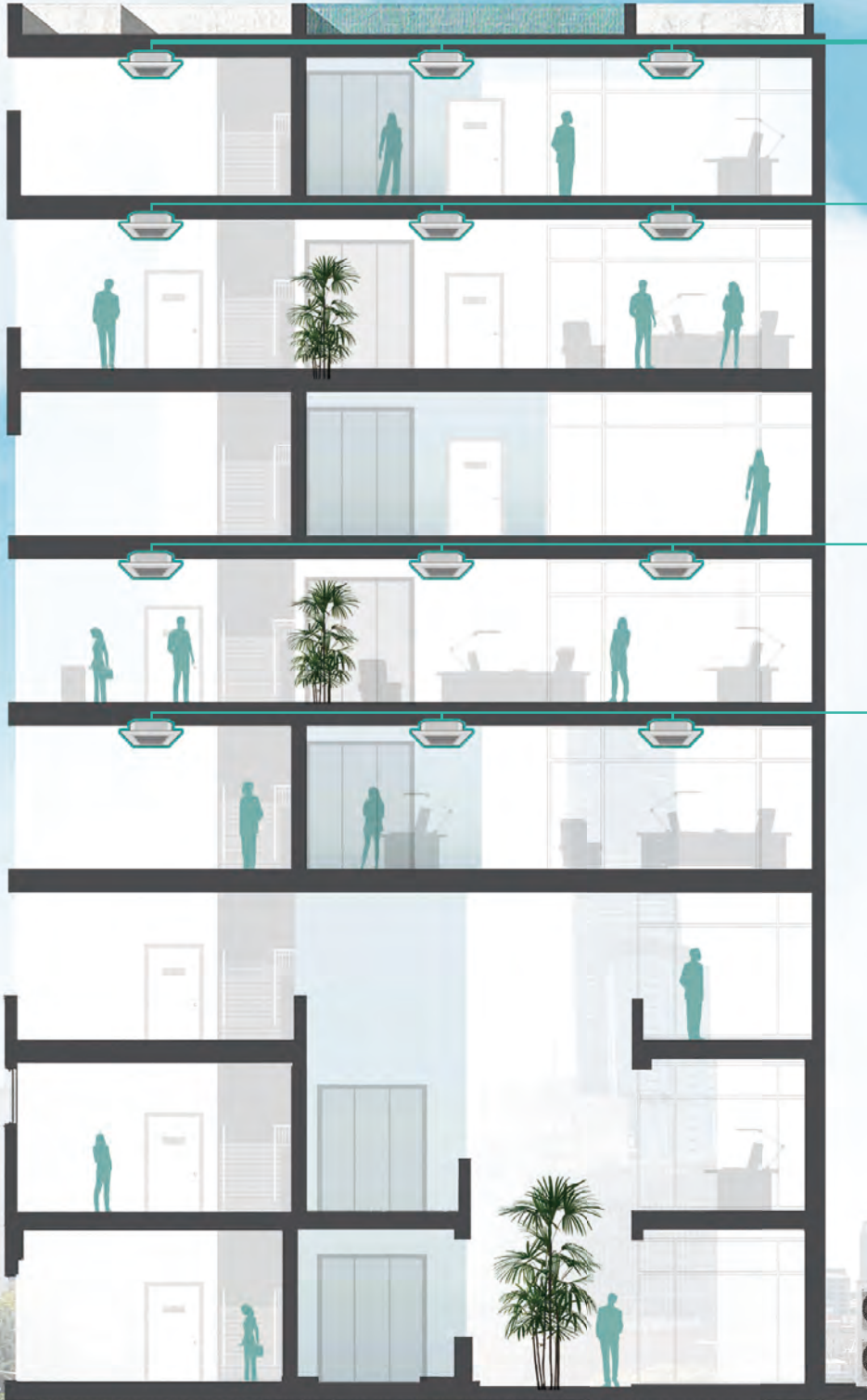

150m (175m)
Longest Piping Length
from ODU - IDU (Equivalent)

300m
Total Piping Length

15m
Height Difference
between IDU - IDU

50m
Height Difference
between ODU - IDU



Smart Load Control Applied

Enhanced comfort and up to 23% energy savings with MULTI V load control

MULTI V S changes indoor discharge air temperature continuously according to load, to save energy.

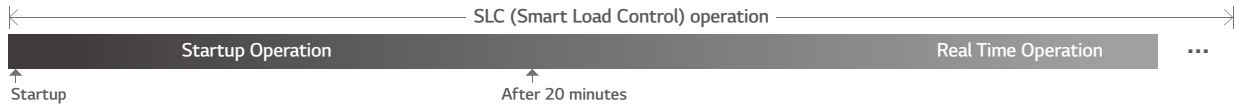

Startup Operation

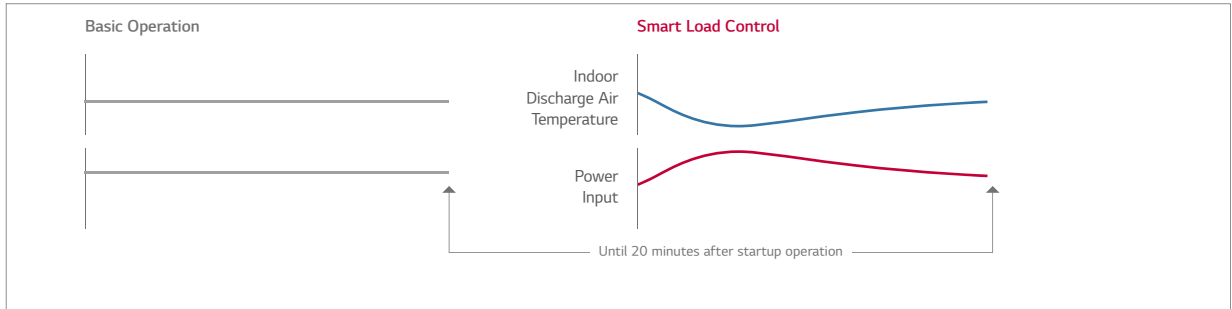

Max 10% Energy saving

- ※ Indoor air discharge temperature
- Energy efficiency increased by 3-step Smart Load Control during startup phase
- Discharge air temperature adjusted according to outdoor and indoor temperature
- Comfort level in cooling / heating operations ensured

Real Time Operation

Basic Operation

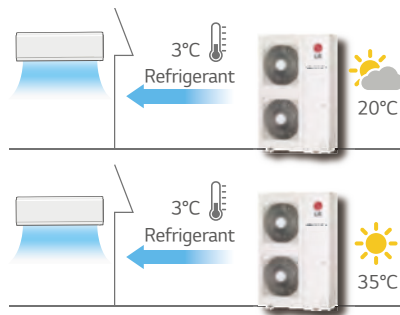

Fixed refrigerant temperature

Smart Load Control

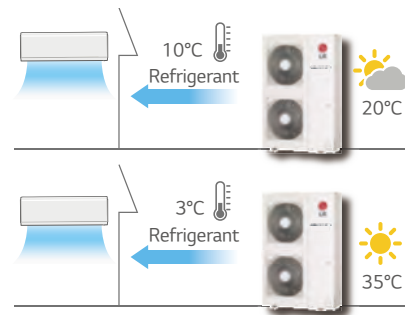

Fixed refrigerant temperature

Max 13% Energy saving

- ※ How to set up : By dip switch in outdoor unit (Referred to Product Data Book) Factory default setting is Off
- Outdoor temperature condition : EER 100% / 75% / 50% / 25% = 35°C (DB) / 30°C (DB) / 25°C (DB) / 20°C (DB)
- Indoor temperature condition : 27°C (DB) / 19°C (WB)
- ※ Dual sensing (Temperature & humidity) smart load control is possible with Remote controller PTEMTB100 (White) / PREMTBB10 (Black)

Inverter Twin Rotary & Inverter Scroll Compressor

Adapted high efficient compressor according to capacity

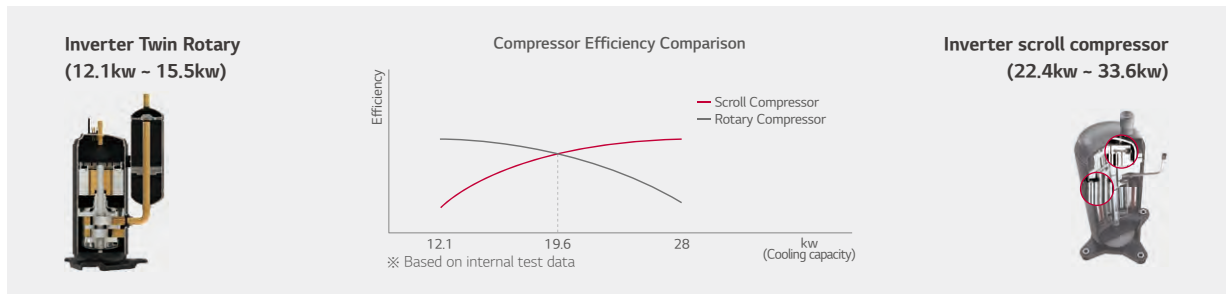

Inverter Twin Rotary

Concentrated Winding Motor

Oil path area is improved by over 50% by increasing the extra stator cavity. Due to this, caloric value of motor is reduced, improving the cooling function of stator coil.



Twin Rotary Rotor

Upper and lower part rotor offset imbalance in shaft rotor rotation. Vibration and noise is reduced. Max torque load decreased by 45% compared to single rotor.



Surface Coating

Surface coating of outstanding abrasion resistance property on vane and crank shaft.



Inverter scroll compressor

Best-in-class Compressor Speed

- Rapid response capability
- Compact core design (Concentrated motor)
- Down to 15Hz : Part load efficiency improvement

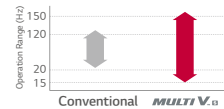

6 Bypass Valve

Compressor reliability is maximized with 6 Bypass Valve

- Prevent compressor damage due to excessively compressed refrigerant more efficiently than 4 Bypass valve



Direct Oil Injection

- Eliminate suction refrigerant gas heat loss through direct oil injection into compression chamber (Efficiency increases)
- Increased reliability with regulated oil supply

Scroll Profile

- The enhanced reliability with regulated oil supply
- Efficiency increases by expanding 96% Bypass area and 17% improved volume ratio by non-uniform scroll thickness

Optimal Heat Exchanger

Maximize efficiency according to different heat exchanger path by cooling and heating

Variable Heat Exchanger Circuit intelligently selects the optimal path. With this smart path selection technology, an average of 6% increase in the efficiency of both operations has been achieved.

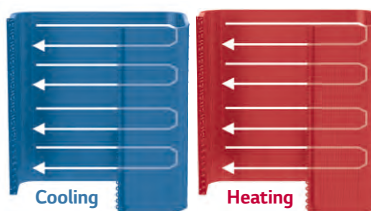
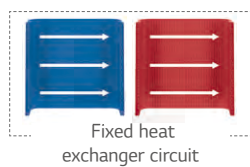

Efficiency performance

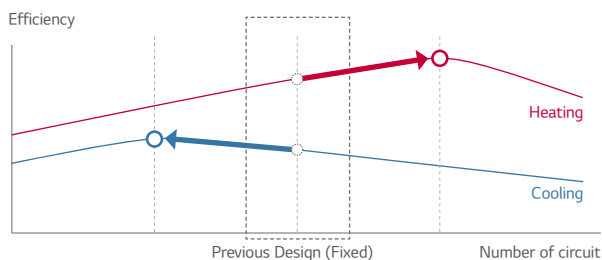

Efficiency up due to Fin shape

Improved heat exchanger efficiency of up to 28%

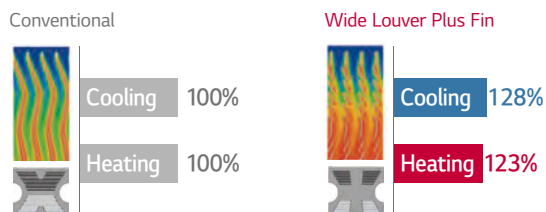

Reliable Refrigerant Components

LG technology allows for superior performance and component durability

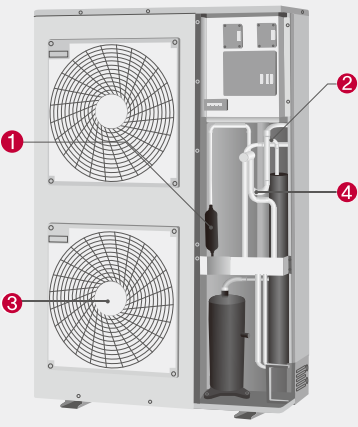

1 Cyclonic oil separator

- Highly reliable and efficient oil separation by centrifuge using cyclonic methods
- High collection efficiency as well as outstanding resistance to high temperature and pressure

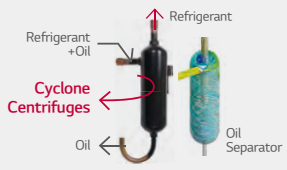

2 Large Volume Accumulator

- Improved reliability by adopting the large volume accumulator (38% volume up compared to conventional)
- Prevents the liquid refrigerant entering the compressor suction
- Maximize efficiency by optimal amount of refrigerant
- Protects compressor breakdown to increase product lifetime



3 BLDC Fan Motor

- The BLDC Fan motor is more efficient than a conventional AC motor, offering an additional 40% energy savings at low speeds and 20% at high speeds

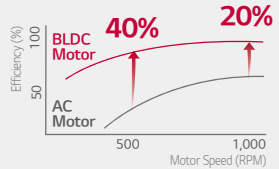

4 Double Sub-cool Interchanger

- Reliability is enhanced by minimizing pressure drop due to high efficiency spiral structure and 2 times larger size
- Long pipe is possible (up to* 1.75m) and high elevation (up to* 50m)
- Reduction of indoor refrigerant noise level



* Based on equivalent pipe length

MULTI V S improved reliability with advanced technology :

- Oil separator
- Accumulator
- Sub-cooling

Smart Control

Pressure control applied for smart, quick and precise response to user's temperature request

Temperature + Pressure Control

Senses and controls pressure directly using pressure sensor for faster and more precise response to load variation.

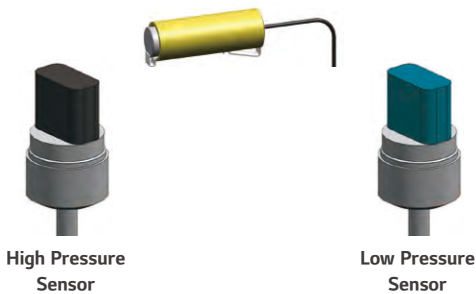

Quick Operating Response

Desired temperature can be reached up to 14% faster in cooling mode with pressure control, allowing more accurate control of indoor environment for maximized comfort.

※ Specifications may vary for each model.

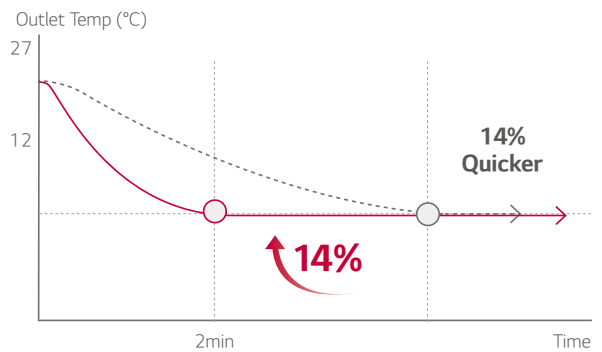

○ Pressure + Temperature Control
○ Temperature Control

Corrosion Resistance Black Fin

Strong durability against high salinity and heavily polluted air

Black Fin ensures continued operation of MULTI V S in highly corrosive environments such as salt laden atmosphere in coastal towns or severe air pollution in industrial cities. This improvement in durability prolongs the product's lifespan and lowers both the operational and maintenance costs.

Corrosion Resistance Proven by Certified Tests

LG Corrosion Resistance solution passed ISO 21207 accelerated corrosion test conducted by an independent test organization and the result has been certified by prestigious global certification organization, TUV.

Certified protection



※ Verification of corrosion resistance performance
 - Test Method B of ISO 21207
 - ASTM B117 / ISO 9227 (10,000 hours)

Enhanced Coating Layers

The black coating with enhanced epoxy resin is applied for strong protection from various corrosive external conditions such as salt contamination and air pollution. Moreover, the hydrophilic film keeps water from accumulating on the heat exchanger's fin, minimizing moisture buildup and eventually making it even more corrosion resistant.

Hydrophilic Coating (Water flow)

The Hydrophilic coating minimizes moisture buildup on the fin.

Complex Resin (Corrosion resistant)

The Black coating provides strong protection from corrosion.

Aluminum fin

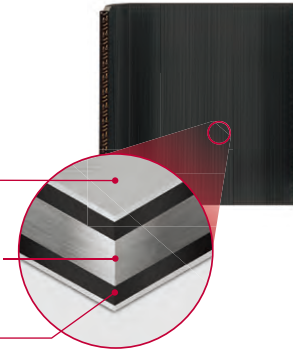

Sufficient Piping Length

Increased piping length allows for flexible design and installation

MULTI V S inverter technology and sub cooling control circuit technology allows greater piping length and outstanding elevation differences. A cooling system can be implemented more flexibly in a shop, office and even high-rise building, reducing the designer's work time and providing more efficient design.

Piping Capabilities

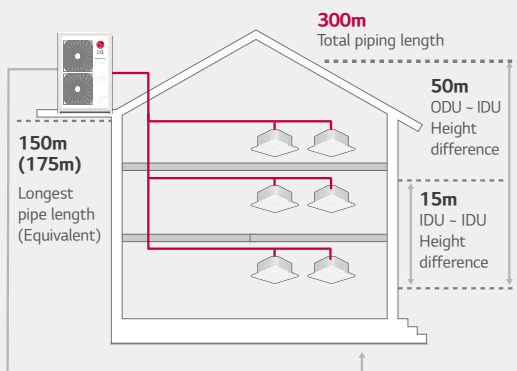

4 Way Piping

- Free design and installation by 4 way piping.

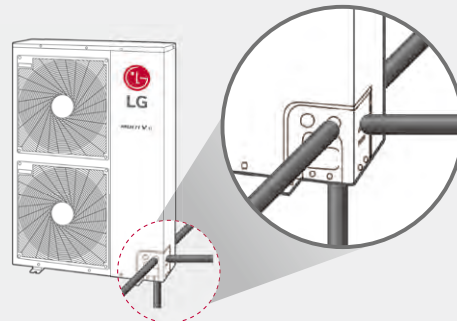

Low Noise Operation

Decreased noise during operation with low noise functionality

At night low noise mode, the noise level can reduce up to 14% in comparison with normal operation mode.

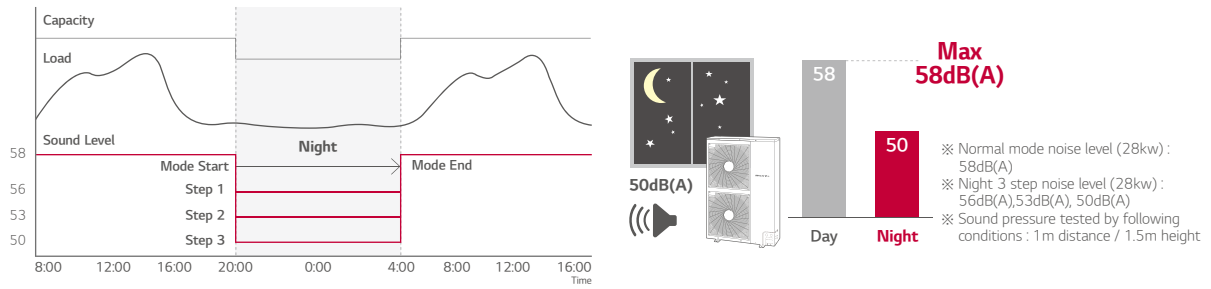

Fan Technology and RPM Control

External static pressure control enables outdoor unit to offer more flexibility in installations.

New axial fan offers higher air volume, increased static pressure, decreased noise and enhanced efficiency.

Fan Technology

The new axial fan has a mogul trailing edge, narrow hub blade and reverse hub, this provides a high efficiency, low noise, wide fan, as well as improving the air flow rate.

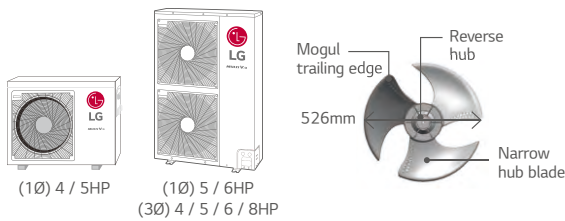

Super cannon fan increases the air volume in 50 CMM and the noise level is decreased by 4dB(A).

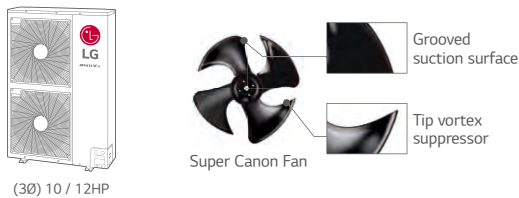

Fan RPM control

Due to the new shroud and ROM control, the air flows straight away from the fan even in high-rise buildings.

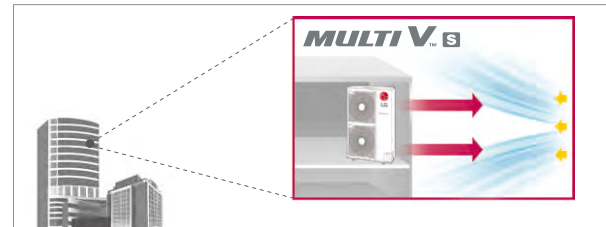
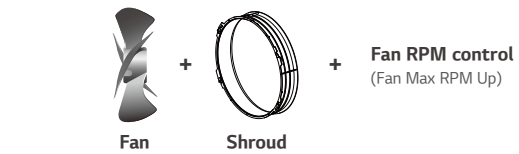

- Straight air flow
- New shroud adopted
- Performs high static pressure

Upgraded Fault Detection and Diagnosis

Easy and convenient maintenance with self-diagnosis

The inclusion of FDD elements - Auto start-up, auto refrigerant check, black box functionality, simultaneous evaluation, and auto refrigerant collection, provides the optimal solution for user reliability and ease of maintenance.

- Auto commissioning mode
- Auto refrigerant collection
- Auto evaluation of refrigerant amount and charging
- Able to access LGMV (LG Monitoring View) by smartphone
- Black box function
- Piping & wiring error check-up
- FDD (Fault Detection and Diagnosis)

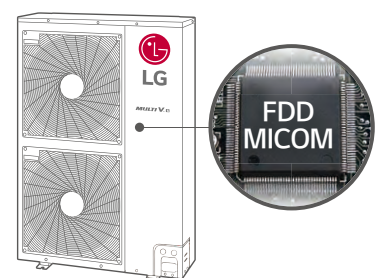

Nomenclature

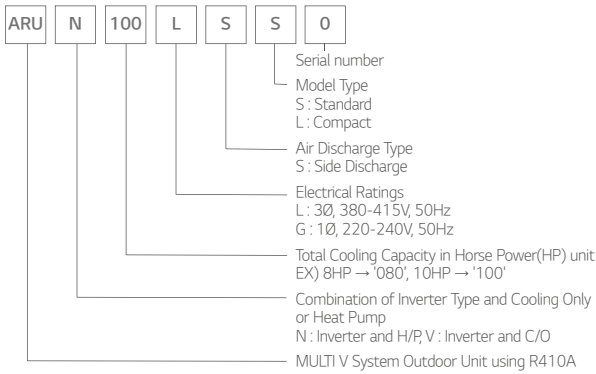

Outdoor Units Function

Category	Functions	MULTI V S
Key Refrigerant Components	Variable Path of Outdoor Unit HEX	-
	HiPOR™ (High Pressure Oil Return)	-
	Humidity Sensor	ARUB060GSS4 only
	Corrosion Resistance Black Fin	○
	Oil Sensor	-
Special Function	Dual Sensing	ARUB060GSS4 only
	Low Noise Operation	○
	High Static Mode of Outdoor Unit Fan	○
	Partial Defrosting	-
	Auto Dust Removal of Outdoor Unit (Fan reverse rotation)	-
	Indoor Cooling Comfort Mode Based Outdoor Temperature	○
	Smart Load Control (SLC) (Changing indoor discharge air temperature according to load)	○
	Outdoor Unit Control Refer to Humidity	ARUB060GSS4 only
	Defrost / Deicing	○
	High Pressure Switch	○
Basic Function	Phase Protection	○
	Restart Delay (3-minutes)	○
	Self Diagnosis	○
	Soft Start	○
	Test Run Function	-
Central Controller	AC Ez (Simple Controller)	PQCSZ250S0
	AC Ez Touch	PACEZA000
	AC Smart IV	PACS4B000
	AC Smart 5	PACS5A000
	ACP (Advanced Control Platform) IV	PACP4B000
	ACP (Advanced Control Platform) 5	PACP5A000
	AC Manager 5	PACM5A000
BNU (Building Network Unit)	ACP Lonworks	PLNWKB000
	ACP BACnet	PQNFB17C0
IO Module (ODU Dry Contact)		PVDSMN000
PDI (Power Distribution Indicator)	Standard	PPWRDB000
	Premium	PQNUD1S40
Cool / Heat Selector		PRDSBM
Cycle Monitoring Device	LGMV	PRCTILO
	Mobile LGMV	PLGMVV100
Additional kit	Refrigerant Charging Kit	○ (Logical operation) Not applied to ARUB060GSS4
	Low Ambient Kit	-
	Variable Water Flow Valve Control Kit	-

※ ○ : Applied, - : Not Applied

ARUN040GSS0

[Unit : mm]

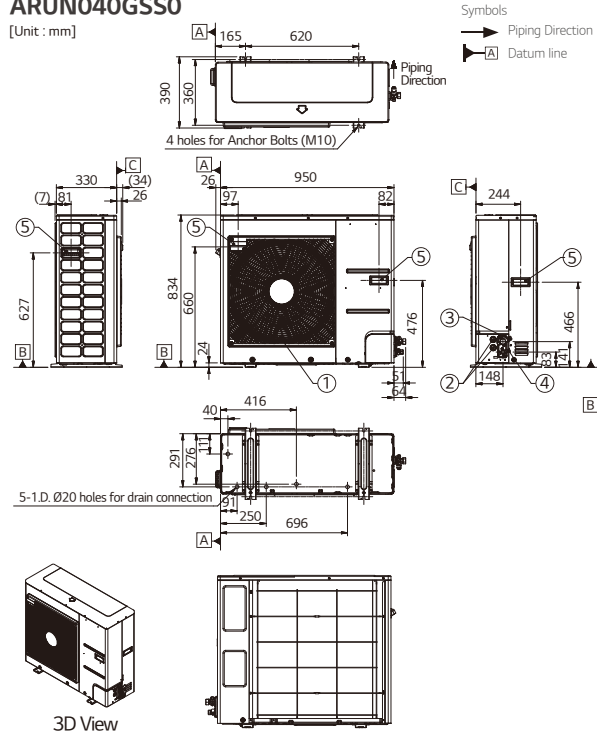

ARUN080LSS0

[Unit : mm]

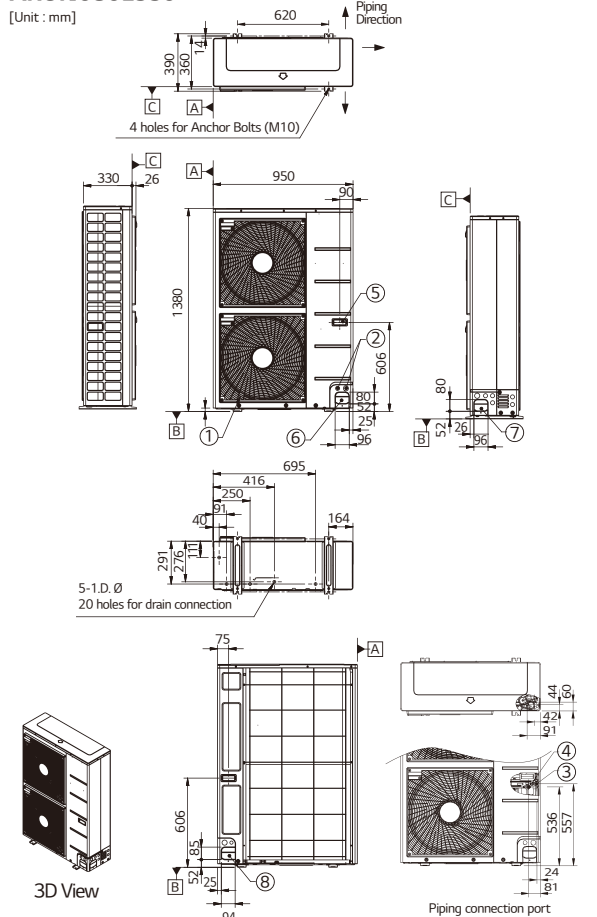

- Note
- Unit should be installed in compliance with the installation manual in the product box.
 - Unit should be grounded in accordance with the local regulation or applicable national codes.
 - All electrical components and materials to be supplied from the site must comply with the local regulations or international codes.
 - Electrical characteristics chapter should be considered for electrical work and design. Especially the power cable and circuit breaker should be selected in accordance with that.

No.	Part Name	Description
1	Air Outlet	-
2	Power and communication cable Hole	-
3	Gas Pipe Connection	Welding joint
4	Liquid Pipe Connection	Welding joint
5	Handle	-
6	Pipe routing hole (front)	-
7	Pipe routing hole (side)	-
8	Pipe routing hole (back)	-

TECHNICAL DATA

Heat Pump

Cooling

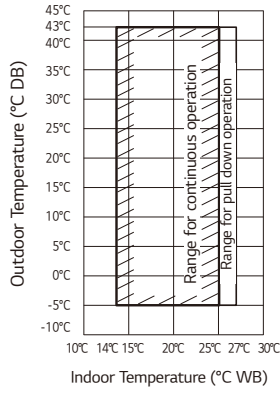

Heating

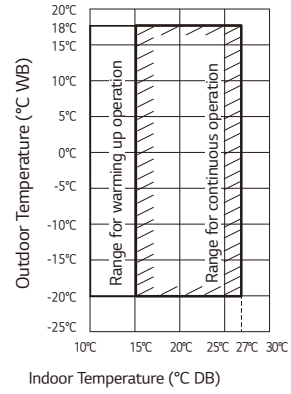

Heat Recovery

Cooling

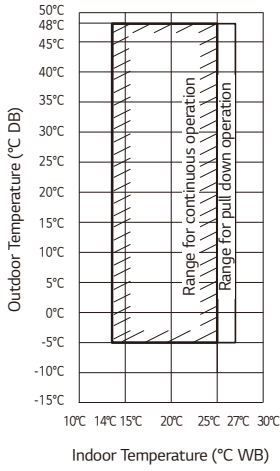

Heating

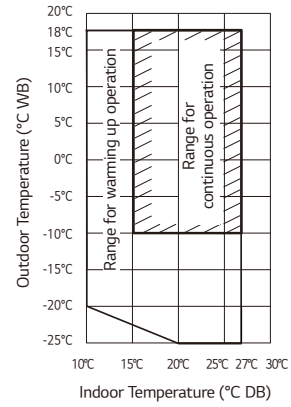

Simultaneous Cooling

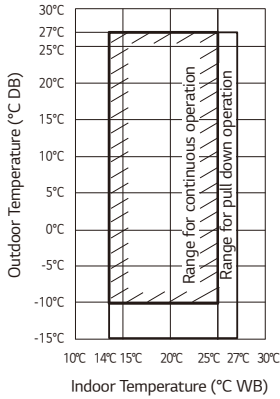

Simultaneous Heating

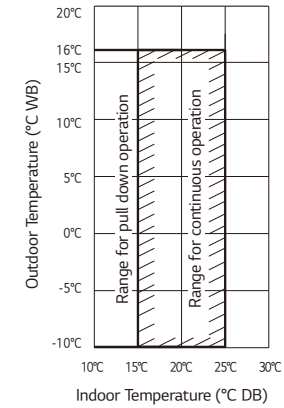

Note

1. These figures assume the following operating conditions : Equivalent piping length : 7.5m
Level difference : 0m
2. Range of pull down operation : If the relative humidity is too high, cooling capacity can be decreased by the sensible

Position of Sound Level Measuring

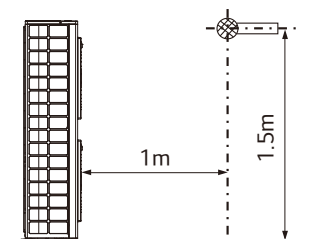

Note

1. These figures assume the following operating conditions :
Equivalent piping length : 7.5m
Level difference : 0m

ARUN040GSS0



LG participates in the ECP programme for EUROVENT VRF program. Check ongoing validity of certification : www.eurovent-certification.com

MULTI VS HEAT PUMP

OUTDOOR UNITS

MULTI VS

HP			4
Model Name			ARUN040GSS0
Capacity	Cooling (Rated)	kW	12.1
	Heating (Rated)	kW	12.5
Input	Cooling (Rated)	kW	4.03
	Heating (Rated)	kW	3.10
EER			3.00
SEER			5.63
COP Rated Capacity			4.03
SCOP			3.97
Exterior	Color (General)		Warm Gray
	RAL Code (Classic)		RAL 7044
Heat Exchanger	Type		Wide Louver Plus
	Type		BLDC Inverter Twin Rotary
Compressor	Combination x No.		(Inverter) x 1
	Motor Output x Number	W x No.	4,000 x 1
	Oil Type		FW68D (PVE)
	Oil Charge		cc
Fan	Type		Axial Flow Fan
	Motor Output x Number	W x No.	124 x 1
	Air Flow Rate (High)		m ³ /min x No.
	Drive		DC INVERTER
	Discharge		Side / Top
Pipe Connection	Liquid Pipe	mm (inch)	Ø9.52 (3/8)
	Gas Pipe	mm (inch)	Ø15.88 (5/8)
Dimensions (W x H x D)			mm x No.
Dimensions (W x H x D) - Shipping			mm x No.
Net Weight			kg x No.
Shipping Weight			kg x No.
Sound Pressure Level	Cooling	dB(A)	50
	Heating	dB(A)	52
Sound Power Level	Cooling	dB(A)	72
	Heating	dB(A)	75
Communication Cable			mm ² x No. (VCTF-SB)
Refrigerant	Refrigerant Name		R410A
	Precharged Amount in factory		kg
	t-CO ₂ eq		3.758
	Control		Electronic Expansion Valve
Power Supply			Ø, V, Hz
Number of Maximum Connectable Indoor Units			8

Note

- Eurovent Test Condition : Type of indoor unit connected is only Ceiling Concealed Duct.
 - Refer to EUROVENT certification regulation for more detail test conditions.
 - Refer to EUROVENT website for test values connected Ceiling Cassette type indoors.
- Performances are based on the following conditions :
 - Cooling Temperature : Indoor 27°C (80.6°F) DB / 19°C (66.2°F) WB / Outdoor 35°C (95°F) DB / 24°C (75.2°F) WB
 - Heating Temperature : Indoor 20°C (68°F) DB / 15°C (59°F) WB / Outdoor 7°C (44.6°F) DB / 6°C (42.8°F) WB
- The maximum combination ratio is 160%.
- Wiring cable size must comply with the applicable local and national codes.
- Due to our policy of innovation some specifications may be changed without notification.
- Sound pressure level is measured on the rated condition in the anechoic rooms by ISO 3745 standard.
 - Sound power level is measured on the rated condition in the semi-anechoic rooms by ISO 9614 standard.
 Therefore, these values can be increased owing to ambient conditions during operation.
- Power factor could vary less than ±1% according to the operating conditions.
- This product contains Fluorinated greenhouse gases. (R410A, GWP(Global warming potential) = 2087.5)

MULTI VS HEAT PUMP R32

ZRUN040GSS0 / ZRUN050GSS0 ZRUN060GSS0



LG participates in the ECP programme for EUROVENT VRF program. Check ongoing validity of certification : www.eurovent-certification.com

HP			4	5	6
Model Name			ZRUN040GSS0	ZRUN050GSS0	ZRUN060GSS0
Capacity	Cooling (Rated)	kW	12.1	14.0	15.5
	Heating (Rated)	kW	12.1	14.0	15.5
	Heating (Max)	kW	14.2	16.0	18.0
Input	Cooling (Rated)	kW	4.26	4.90	5.64
	Heating (Rated)	kW	3.03	3.48	3.95
EER (Rated)			2.84	2.86	2.75
SEER			6.69	6.44	6.59
COP (Rated)			4.00	4.02	3.92
SCOP			3.87	3.81	4.07
Exterior	Color		Warm Gray	Warm Gray	Warm Gray
	RAL Code		RAL 7044	RAL 7044	RAL 7044
Heat Exchanger	Type		Wide Louver Plus	Wide Louver Plus	Wide Louver Plus
Compressor	Type		LG Inverter Scroll	LG Inverter Scroll	LG Inverter Scroll
	Combination x No.		(Inverter) x 1	(Inverter) x 1	(Inverter) x 1
	Motor Output x Number	W x No.	3,198 x 1	3,198 x 1	3,198 x 1
	Oil Type		FW68D (PVE)	FW68D (PVE)	FW68D (PVE)
	Oil Charge	cc	1,100	1,100	1,100
Fan	Type		Axial Flow Fan	Axial Flow Fan	Axial Flow Fan
	Motor Output x Number	W x No.	124 x 1	198 x 1	198 x 1
	Air Flow Rate (High)	m ³ /min x No.	60	80	80
	Drive		DC INVERTER	DC INVERTER	DC INVERTER
	Discharge	Side / Top	Side	Side	Side
Pipe Connection	Liquid Pipe	mm (inch)	Ø9.52 (3/8)	Ø9.52 (3/8)	Ø9.52 (3/8)
	Gas Pipe	mm (inch)	Ø15.88 (5/8)	Ø15.88 (5/8)	Ø19.05 (3/4)
Dimensions (W x H x D)		mm x No.	950 x 834 x 330	950 x 834 x 330	950 x 834 x 330
Dimensions (W x H x D) - Shipping		mm x No.	1,147 x 919 x 461	1,147 x 919 x 461	1,147 x 919 x 461
Net Weight		kg x No.	64.7	71.6	71.6
Shipping Weight		kg x No.	73.7	79.6	79.6
Sound Pressure Level	Cooling	dB(A)	51	57	57
	Heating	dB(A)	55	60	60
Sound Power Level	Cooling	dB(A)	67	70	71
	Heating	dB(A)	71	74	75
Communication Cable		mm ² x No. (VCTF-SB)	2C x 1.0 - 1.5	2C x 1.0 - 1.5	2C x 1.0 - 1.5
Refrigerant	Refrigerant name		R32	R32	R32
	Precharged Amount	kg	1.5	2.0	2.0
	t-CO ₂ eq		1.013	1.350	1.350
	Control		Electronic Expansion Valve	Electronic Expansion Valve	Electronic Expansion Valve
Power Supply		Ø, V, Hz	220 - 230 - 240, 1, 50	220 - 230 - 240, 1, 50	220 - 230 - 240, 1, 50
Number of maximum connectable indoor units			8	10	13

Note

- Due to our policy of innovation some specifications may be changed without notification.
- Wiring cable size must comply with the applicable local and national codes. And "Electric characteristics" chapter should be considered for electrical work and design. Especially the power cable and circuit breaker should be selected in accordance with that.
- Sound pressure level is measured on the rated condition in the anechoic rooms by ISO 3745 standard. Sound power level is measured on the rated condition in the semi-anechoic rooms by ISO 9614 standard. Therefore, these values can be increased owing to ambient conditions during operation.

4. Performances are based on the following conditions :

- Cooling : Indoor Ambient Temp 27°CDB / 19°CWB, Outdoor Ambient Temp 35°CDB / 24°CWB
- Heating : Indoor Ambient Temp 20°CDB / 15°CWB, Outdoor Ambient Temp 7°CDB / 6°CWB
- Interconnected Pipe Length is 7.5m and difference of Elevation (Outdoor - Indoor Unit) is 0m.

5. EUROVENT Test Condition :

- Performance values on this PDB are based on Ceiling mounted cassette combination.
- Refer to EUROVENT web site(www.eurovent-certification.com) for other indoor unit combination and more detail test conditions.

6. The maximum combination ratio is 160%.

7. This product contains Fluorinated greenhouse gases. (R32, GWP (Global warming potential) = 675)

ZRUN040LSSO / ZRUN050LSSO
ZRUN060LSSO



LG participates in the ECP programme for EUROVENT VRF program. Check ongoing validity of certification : www.eurovent-certification.com

MULTI V S HEAT PUMP R32

OUTDOOR UNITS

MULTI V S R32

HP			4	5	6
Model Name			ZRUN040LSSO	ZRUN050LSSO	ZRUN060LSSO
Capacity	Cooling (Rated)	kW	12.1	14.0	15.5
	Heating (Rated)	kW	12.1	14.0	15.5
	Heating (Max)	kW	14.2	16.0	18.0
Input	Cooling (Rated)	kW	4.26	4.90	5.64
	Heating (Rated)	kW	3.03	3.48	3.95
EER (Rated)			2.84	2.86	2.75
SEER			6.69	6.44	6.59
COP (Rated)			4.00	4.02	3.92
SCOP			3.87	3.81	4.07
Exterior	Color		Warm Gray	Warm Gray	Warm Gray
	RAL Code		RAL 7044	RAL 7044	RAL 7044
Heat Exchanger	Type		Wide Louver Plus	Wide Louver Plus	Wide Louver Plus
Compressor	Type		LG Inverter Scroll	LG Inverter Scroll	LG Inverter Scroll
	Combination x No.		(Inverter) x 1	(Inverter) x 1	(Inverter) x 1
	Motor Output x Number	W x No.	3,198 x 1	3,198 x 1	3,198 x 1
	Oil Type		FW68D (PVE)	FW68D (PVE)	FW68D (PVE)
	Oil Charge	cc	1,100	1,100	1,100
Fan	Type		Axial Flow Fan	Axial Flow Fan	Axial Flow Fan
	Motor Output x Number	W x No.	124 x 1	198 x 1	198 x 1
	Air Flow Rate (High)	m ³ /min x No.	60	80	80
	Drive		DC INVERTER	DC INVERTER	DC INVERTER
	Discharge	Side / Top	Side	Side	Side
Pipe Connection	Liquid Pipe	mm (inch)	Ø9.52 (3/8)	Ø9.52 (3/8)	Ø9.52 (3/8)
	Gas Pipe	mm (inch)	Ø15.88 (5/8)	Ø15.88 (5/8)	Ø19.05 (3/4)
Dimensions (W x H x D)			950 x 834 x 330	950 x 834 x 330	950 x 834 x 330
Dimensions (W x H x D) - Shipping			1,147 x 919 x 461	1,147 x 919 x 461	1,147 x 919 x 461
Net Weight			64.7	71.6	71.6
Shipping Weight			73.7	79.6	79.6
Sound Pressure Level	Cooling	dB(A)	51	57	57
	Heating	dB(A)	55	60	60
Sound Power Level	Cooling	dB(A)	67	70	71
	Heating	dB(A)	71	74	75
Communication Cable			2C x 1.0 ~ 1.5	2C x 1.0 ~ 1.5	2C x 1.0 ~ 1.5
Refrigerant	Refrigerant name		R32	R32	R32
	Precharged Amount	kg	1.5	2.0	2.0
	t-CO ₂ eq		1.013	1.350	1.350
	Control		Electronic Expansion Valve	Electronic Expansion Valve	Electronic Expansion Valve
Power Supply			Ø, V, Hz	380 - 400 - 415, 3, 50	380 - 400 - 415, 3, 50
Number of maximum connectable indoor units			8	10	13

Note

- Due to our policy of innovation some specifications may be changed without notification.
- Wiring cable size must comply with the applicable local and national codes. And "Electric characteristics" chapter should be considered for electrical work and design. Especially the power cable and circuit breaker should be selected in accordance with that.
- Sound pressure level is measured on the rated condition in the anechoic rooms by ISO 3745 standard. Sound power level is measured on the rated condition in the semi-anechoic rooms by ISO 9614 standard. Therefore, these values can be increased owing to ambient conditions during operation.

4. Performances are based on the following conditions :

- Cooling : Indoor Ambient Temp 27°CDB / 19°CWB, Outdoor Ambient Temp 35°CDB / 24°CWB
- Heating : Indoor Ambient Temp 20°CDB / 15°CWB, Outdoor Ambient Temp 7°CDB / 6°CWB
- Interconnected Pipe Length is 7.5m and difference of Elevation (Outdoor - Indoor Unit) is 0m.

5. EUROVENT Test Condition :

- Performance values on the this PDB are based on Ceiling mounted cassette combination.
- Refer to EUROVENT web site(www.eurovent-certification.com) for other indoor unit combination and more detail test conditions.

6. The maximum combination ratio is 160%.

- This product contains Fluorinated greenhouse gases. (R32, GWP (Global warming potential) = 675)

MULTI VS HEAT PUMP

ARUN050GSS0 / ARUN060GSS0



LG participates in the ECP programme for EUROVENT VRF program. Check ongoing validity of certification : www.eurovent-certification.com

HP			5	6
Model Name			ARUN050GSS0	ARUN060GSS0
Capacity	Cooling (Rated)	kW	14.0	15.5
	Heating (Rated)	kW	16.0	18.0
Input	Cooling (Rated)	kW	4.59	5.17
	Heating (Rated)	kW	4.18	5.00
EER			3.05	3.00
SEER			7.40	7.53
COP Rated Capacity			3.83	3.60
SCOP			4.16	4.35
Exterior	Color (General)		Warm Gray	Warm Gray
	RAL Code (Classic)		RAL 7044	RAL 7044
Heat Exchanger	Type		Wide Louver Plus	Wide Louver Plus
	Type		BLDC Inverter Twin Rotary	BLDC Inverter Twin Rotary
Compressor	Combination x No.		(Inverter) x 1	(Inverter) x 1
	Motor Output x Number	W x No.	4,000 x 1	4,000 x 1
	Oil Type		FW68D (PVE)	FW68D (PVE)
	Oil Charge	cc	1,300	1,300
Fan	Type		Axial Flow Fan	Axial Flow Fan
	Motor Output x Number	W x No.	124 x 2	124 x 2
	Air Flow Rate (High)	m ³ /min x No.	110	110
	Drive		DC INVERTER	DC INVERTER
	Discharge	Side / Top	Side	Side
Pipe Connection	Liquid Pipe	mm (inch)	Ø9.52 (3/8)	Ø9.52 (3/8)
	Gas Pipe	mm (inch)	Ø15.88 (5/8)	Ø19.05 (3/4)
Dimensions (W x H x D)			950 x 1,380 x 330	950 x 1,380 x 330
Dimensions (W x H x D) - Shipping			(1,065 x 918 x 461) x 1	(1,065 x 918 x 461) x 1
Net Weight			94	94
Shipping Weight			106	106
Sound Pressure Level	Cooling	dB(A)	51	52
	Heating	dB(A)	53	54
Sound Power Level	Cooling	dB(A)	72	72
	Heating	dB(A)	76	77
Communication Cable			2C x 1.0 - 1.5	2C x 1.0 - 1.5
Refrigerant	Refrigerant Name		R410A	R410A
	Precharged Amount in factory	kg	3.0	3.0
	t-CO ₂ eq		6.263	6.263
	Control		Electronic Expansion Valve	Electronic Expansion Valve
Power Supply	Ø, V, Hz		220-240, 1, 50	220-240, 1, 50
			220, 1, 60	220, 1, 60
Number of Maximum Connectable Indoor Units			10	13

Note

- Eurovent Test Condition : Type of indoor unit connected is only Ceiling Concealed Duct.
 - Refer to EUROVENT certification regulation for more detail test conditions.
 - Refer to EUROVENT website for test values connected Ceiling Cassette type indoors.
- Performances are based on the following conditions:
 - Cooling Temperature : Indoor 27°C (80.6°F) DB / 19°C (66.2°F) WB / Outdoor 35°C (95°F) DB / 24°C (75.2°F) WB
 - Heating Temperature : Indoor 20°C (68°F) DB / 15°C (59°F) WB / Outdoor 7°C (44.6°F) DB / 6°C (42.8°F) WB
- The maximum combination ratio is 160%.
- Wiring cable size must comply with the applicable local and national codes.
- Due to our policy of innovation some specifications may be changed without notification.
- Sound pressure level is measured on the rated condition in the anechoic rooms by ISO 3745 standard. Sound power level is measured on the rated condition in the semi-anechoic rooms by ISO 9614 standard. Therefore, these values can be increased owing to ambient conditions during operation.
- Power factor could vary less than ±1% according to the operating conditions.
- This product contains Fluorinated greenhouse gases. (R410A, GWP(Global warming potential) = 2087.5)

ARUN040LSS0 / ARUN050LSS0
ARUN060LSS0



LG participates in the ECP programme for EUROVENT VRF program. Check ongoing validity of certification : www.eurovent-certification.com

MULTI VS HEAT PUMP

OUTDOOR UNITS

MULTI VS

HP			4	5	6
Model Name			ARUN040LSS0	ARUN050LSS0	ARUN060LSS0
Capacity	Cooling (Rated)	kW	12.1	14.0	15.5
	Heating (Rated)	kW	12.5	16.0	18.0
Input	Cooling (Rated)	kW	3.39	4.59	5.17
	Heating (Rated)	kW	2.75	4.18	5.00
EER			3.57	3.05	3.00
SEER			7.42	7.40	7.53
COP Rated Capacity			4.55	3.83	3.60
SCOP			4.30	4.16	4.35
Exterior	Color (General)		Warm Gray	Warm Gray	Warm Gray
	RAL Code (Classic)		RAL 7044	RAL 7044	RAL 7044
Heat Exchanger	Type		Wide Louver Plus	Wide Louver Plus	Wide Louver Plus
	Type		BLDC Inverter Twin Rotary	BLDC Inverter Twin Rotary	BLDC Inverter Twin Rotary
Compressor	Combination x No.		(Inverter) x 1	(Inverter) x 1	(Inverter) x 1
	Motor Output x Number	W x No.	4,000 x 1	4,000 x 1	4,000 x 1
	Oil Type		FW68D (PVE)	FW68D (PVE)	FW68D (PVE)
	Oil Charge	cc	1,300	1,300	1,300
	Type		Axial Flow Fan	Axial Flow Fan	Axial Flow Fan
Fan	Motor Output x Number	W x No.	124 x 2	124 x 2	124 x 2
	Air Flow Rate (High)	m ³ /min x No.	110	110	110
	Drive		DC INVERTER	DC INVERTER	DC INVERTER
	Discharge	Side / Top	Side	Side	Side
	Pipe Connection	Liquid Pipe	mm (inch)	Ø9.52 (3/8)	Ø9.52 (3/8)
	Gas Pipe	mm (inch)	Ø15.883(5/8)	Ø15.88 (5/8)	Ø19.05 (3/4)
Dimensions (W x H x D)			mm x No. 950 x 1,380 x 330	950 x 1,380 x 330	950 x 1,380 x 330
Dimensions (W x H x D) - Shipping			mm x No. (1,065 x 918 x 461) x 1	(1,065 x 918 x 461) x 1	(1,065 x 918 x 461) x 1
Net Weight			kg x No. 96	96	96
Shipping Weight			kg x No. 108	108	108
Sound Pressure Level	Cooling	dB(A)	50	51	52
	Heating	dB(A)	52	53	54
Sound Power Level	Cooling	dB(A)	72	72	72
	Heating	dB(A)	76	76	77
Communication Cable			mm ² x No. (VCTF-SB) 2C x 1.0 - 1.5	2C x 1.0 - 1.5	2C x 1.0 - 1.5
Refrigerant	Refrigerant Name		R410A	R410A	R410A
	Precharged Amount in factory	kg	3.0	3.0	3.0
	t-CO ₂ eq		6.263	6.263	6.263
	Control		Electronic Expansion Valve	Electronic Expansion Valve	Electronic Expansion Valve
Power Supply			Ø, V, Hz 380-415, 3, 50	380-415, 3, 50	380-415, 3, 50
			380, 3, 60	380, 3, 60	380, 3, 60
Number of Maximum Connectable Indoor Units			8	10	13

Note

- Eurovent Test Condition : Type of indoor unit connected is only Ceiling Concealed Duct.
 - Refer to EUROVENT certification regulation for more detail test conditions.
 - Refer to EUROVENT website for test values connected Ceiling Cassette type indoors.
- Performances are based on the following conditions :
 - Cooling Temperature : Indoor 27°C (80.6°F) DB / 19°C (66.2°F) WB / Outdoor 35°C (95°F) DB / 24°C (75.2°F) WB
 - Heating Temperature : Indoor 20°C (68°F) DB / 15°C (59°F) WB / Outdoor 7°C (44.6°F) DB / 6°C (42.8°F) WB
- The maximum combination ratio is 160%.
- Wiring cable size must comply with the applicable local and national codes.
- Due to our policy of innovation some specifications may be changed without notification.
- Sound pressure level is measured on the rated condition in the anechoic rooms by ISO 3745 standard.
 - Sound power level is measured on the rated condition in the semi-anechoic rooms by ISO 9614 standard.
 - Therefore, these values can be increased owing to ambient conditions during operation.
- Power factor could vary less than ±1% according to the operating conditions.
- This product contains Fluorinated greenhouse gases. (R410A, GWP(Global warming potential) = 2087.5)

ARUN080LSS0 / ARUN100LSS0 ARUN120LSS0



LG participates in the ECP programme for EUROVENT VRF program. Check ongoing validity of certification : www.eurovent-certification.com

HP			8	10	12
Model Name			ARUN080LSS0	ARUN100LSS0	ARUN120LSS0
Capacity	Cooling (Rated)	kW	22.4	28.0	33.6
	Heating (Rated)	kW	24.5	30.6	36.7
Input	Cooling (Rated)	kW	8.45	12.44	15.27
	Heating (Rated)	kW	6.96	8.50	12.23
EER			2.65	2.25	2.20
SEER			7.13	6.28	6.50
COP Rated Capacity			3.52	3.60	3.00
SCOP			4.53	4.21	4.32
Exterior	Color (General)		Warm Gray	Warm Gray	Warm Gray
	RAL Code (Classic)		RAL 7044	RAL 7044	RAL 7044
Heat Exchanger	Type		Wide Louver Plus	Wide Louver Plus	Wide Louver Plus
	Type		Hermetically Sealed Scroll	Hermetically Sealed Scroll	Hermetically Sealed Scroll
Compressor	Combination x No.		(Inverter) x 1	(Inverter) x 1	(Inverter) x 1
	Motor Output x Number	W x No.	4,200 x 1	5,300 x 1	5,300 x 1
	Oil Type		FW68D (PVE)	FW68D (PVE)	FW68D (PVE)
	Oil Charge	cc	2,400	2,600	3,400
Fan	Type		Propeller fan	Propeller fan	Propeller fan
	Motor Output x Number	W x No.	124 x 2	250 x 2	250 x 2
	Air Flow Rate (High)	m ³ /min x No.	140	190	190
	Drive		DC INVERTER	DC INVERTER	DC INVERTER
	Discharge	Side / Top	Side	Side	Side
Pipe Connection	Liquid Pipe	mm (inch)	Ø9.52 (3/8)	Ø9.52 (3/8)	Ø12.7 (1/2)
	Gas Pipe	mm (inch)	Ø19.05 (3/4)	Ø22.2 (7/8)	Ø28.58 (1-1/8)
Dimensions (W x H x D)			950 x 1,380 x 330	1,090 x 1,625 x 380	1,090 x 1,625 x 380
Dimensions (W x H x D) - Shipping			(1,065 x 918 x 461) x 1	(1,065 x 918 x 461) x 1	(1,065 x 918 x 461) x 1
Net Weight			115	142	155
Shipping Weight			127	158	171
Sound Pressure Level	Cooling	dB(A)	57	58	60
	Heating	dB(A)	57	58	60
Sound Power Level	Cooling	dB(A)	78	77	78
	Heating	dB(A)	81	79	82
Communication Cable			2C x 1.0 - 1.5	2C x 1.0 - 1.5	2C x 1.0 - 1.5
Refrigerant	Refrigerant Name		R410A	R410A	R410A
	Precharged Amount in factory	kg	3.5	4.5	6.0
	t-CO ₂ eq		7.306	9.394	12.525
	Control		Electronic Expansion Valve	Electronic Expansion Valve	Electronic Expansion Valve
Power Supply	Ø, V, Hz		380-415, 3, 50	380-415, 3, 50	380-415, 3, 50
			380, 3, 60	380, 3, 60	380, 3, 60
Number of Maximum Connectable Indoor Units			13	16	20

Note

- Eurovent Test Condition : Type of indoor unit connected is only Ceiling Concealed Duct.
 - Refer to EUROVENT certification regulation for more detail test conditions.
 - Refer to EUROVENT website for test values connected Ceiling Cassette type indoors.
- Performances are based on the following conditions :
 - Cooling Temperature : Indoor 27°C (80.6°F) DB / 19°C (66.2°F) WB / Outdoor 35°C (95°F) DB / 24°C (75.2°F) WB
 - Heating Temperature : Indoor 20°C (68°F) DB / 15°C (59°F) WB / Outdoor 7°C (44.6°F) DB / 6°C (42.8°F) WB
- The maximum combination ratio is 160%.
- Wiring cable size must comply with the applicable local and national codes.
- Due to our policy of innovation some specifications may be changed without notification.
- Sound pressure level is measured on the rated condition in the anechoic rooms by ISO 3745 standard. Sound power level is measured on the rated condition in the semi-anechoic rooms by ISO 9614 standard. Therefore, these values can be increased owing to ambient conditions during operation.
- Power factor could vary less than ±1% according to the operating conditions.
- This product contains Fluorinated greenhouse gases. (R410A, GWP(Global warming potential) = 2087.5)

ARUB060GSS4



LG participates in the ECP programme for EUROVENT VRF program. Check ongoing validity of certification : www.eurovent-certification.com

MULTI VS HEAT RECOVERY

OUTDOOR UNITS

MULTI VS

HP			6
Model Name			ARUB060GSS4
Capacity	Cooling (Rated)	kW	15.5
	Heating (Rated)	kW	18.0
Input	Cooling (Rated)	kW	5.74
	Heating (Rated)	kW	5.14
EER			2.70
SEER			5.92
COP Rated Capacity			3.50
SCOP			3.79
Exterior	Color		Warm Gray
	RAL Code (Classic)		RAL 7044
Heat Exchanger	Type		Wide Louver Plus
	Type		Hermetically Sealed Scroll
Compressor	Combination x No.		(Inverter) x 1
	Motor Output x Number	W x No.	4,200 x 1
	Oil Type		FW68D (PVE)
	Oil Charge	cc	1,700
Fan	Type		Axial Flow Fan
	Motor Output x Number	W x No.	124 x 2
	Air Flow Rate (High)	m ³ /min x No.	110
	Drive		DC INVERTER
	Discharge	Side / Top	Side
Pipe Connection #1	Liquid Pipe	mm (inch)	Ø9.52 (3/8)
	Low Pressure Gas Pipe	mm (inch)	Ø19.05 (3/4)
	High Pressure Gas Pipe	mm (inch)	Ø15.88 (5/8)
Dimensions (W x H x D)			950 x 1,380 x 330
Dimensions (W x H x D) - shipping			(1,140 x 1,549 x 466) x 1
Net Weight			118
Shipping Weight			132
Sound Pressure Level	Cooling	dB(A)	56
	Heating	dB(A)	58
Sound Power Level	Cooling	dB(A)	76
	Heating	dB(A)	78
Communication Cable			mm ² x No. (VCTF-SB) 2C x 1.0 - 1.5
Refrigerant	Refrigerant Name		R410A
	Precharged Amount in factory	kg	3.5
	t-CO ₂ eq		7.306
	Control		Electronic Expansion Valve
Power Supply			Ø, V, Hz 220-230-240, 1, 50/60
Number of Maximum Connectable Indoor Units			13

Note

- Eurovent Test Condition : Type of indoor unit connected is only Ceiling Concealed Duct.
 - Refer to EUROVENT certification regulation for more detail test conditions.
 - Refer to EUROVENT website for test values connected Ceiling Cassette type indoors.
- Performances are based on the following conditions :
 - Cooling Temperature : Indoor 27°C (80.6°F) DB / 19°C (66.2°F) WB / Outdoor 35°C (95°F) DB / 24°C (75.2°F) WB
 - Heating Temperature : Indoor 20°C (68°F) DB / 15°C (59°F) WB / Outdoor 7°C (44.6°F) DB / 6°C (42.8°F) WB
- The maximum combination ratio is 160%.
- Wiring cable size must comply with the applicable local and national codes.
- Due to our policy of innovation some specifications may be changed without notification.
- Sound pressure level is measured on the rated condition in the anechoic rooms by ISO 3745 standard. Sound power level is measured on the rated condition in the semi-anechoic rooms by ISO 9614 standard. Therefore, these values can be increased owing to ambient conditons during operation.
- Power factor could vary less than ±1% according to the operating conditions.
- This product contains Fluorinated greenhouse gases. (R410A, GWP(Global warming potential) = 2087.5)

Energy Savings

Energy consumption can be reduced as indoor heat is absorbed and transferred to hot water supply.

Conventional

Absorbed heat is released to outdoor air.



Energy Savings

Energy consumption can be reduced as indoor heat is absorbed and transferred to hot water supply.

MULTI V S Heat Recovery with HYDRO KIT

Absorbed heat from indoor space is used for making hot water.

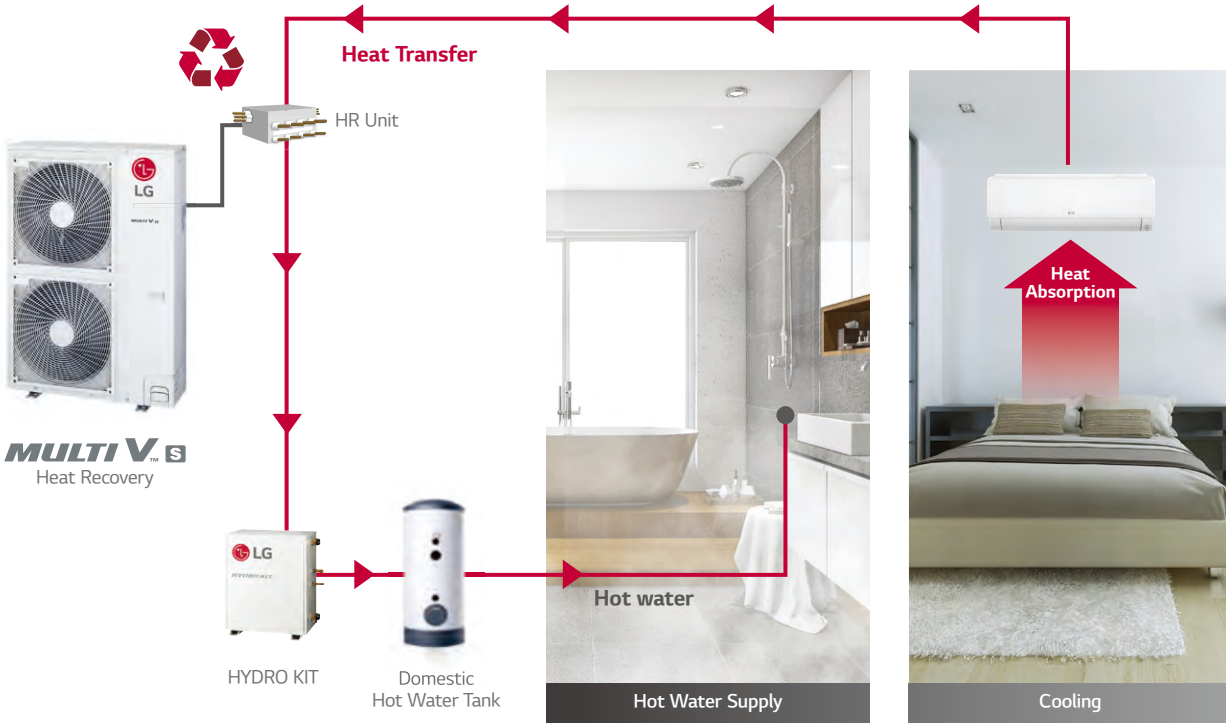

MULTI VTM S



- Air cooled VRF Heat pump
- 12.1 ~ 15.5kW (based on cooling capacity)
- Both 1Ø, 220 ~ 240V, 50Hz and 3Ø, 380 ~ 415V, 50Hz
- Side discharge outdoor unit



WHY R32 REFRIGERANT

Lower Global Warming Potential (GWP)

What is GWP?

Global Warming Potential is a measure that allows for an accurate comparison of the environmental impact of different gases. GWP measures how much energy the emissions of 1 ton of a gas will absorb over a given period of time, relative to the emissions of 1 ton of carbon dioxide (CO₂).

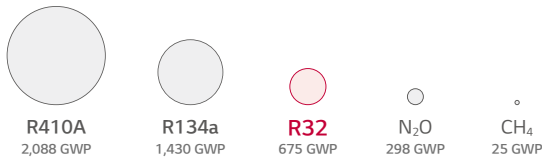

Global Trend and EU Regulation for F-Gas

HFC* Phase Down 79% by 2030.

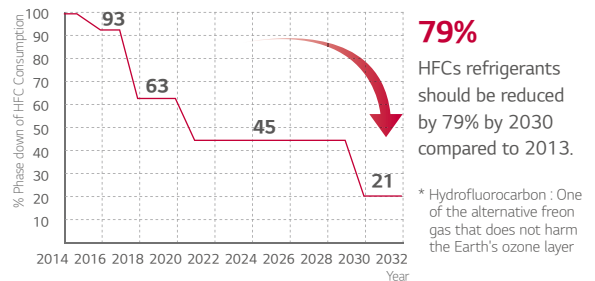

Cost Savings with R32

Higher Efficiency

Savings on cost of energy consumption.



Reduced Equipment Sizes

Savings on product purchase and labor cost for installation and maintenance.



Less Refrigerant Charge

Savings on cost of injecting & replacing refrigerant.



Reduced Refrigerant Volume

Savings on refrigerant purchase and recycling costs.



Higher Efficiency

LG Multi V S achieved high efficiency through technology of biomimetic fan and revolutionary scroll compressor.

EER 3.65
COP 4.10

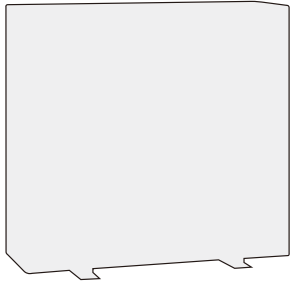

VS



Superior to competitor's

EER 4.20
COP 5.15

EER 15% ↑ COP 25% ↑

※ The values based on 5HP model

Compact Size & Light Weight

Its compact size and light weight make it easy to install and optimize space. (5/6HP)



Less Refrigerant Charge

LG reduced refrigerant charge by applying environment-conscious refrigerant R32.

Total amount : 5.6 kg
Factory Charging : 3 kg



Total amount : 4.3 kg **23% ↓**
Factory Charging : 2 kg



※ IDU (Wall Mounted Unit) : 5 kBTu/h, 8 EA
※ This result can be different depending on actual environment

Corrosion Resistance Black Fin

Enhanced Coating Layers

The black coating with enhanced epoxy resin is applied for strong protection from various corrosive external conditions such as salt contamination and air pollution. Moreover, the hydrophilic film keeps water from accumulating on the heat exchanger's fin, minimizing moisture buildup and eventually making it even more corrosion resistant.

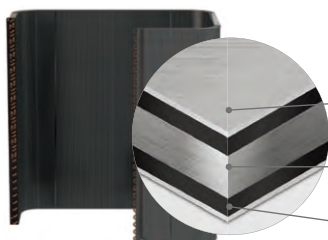

- Hydrophilic Coating (Water flow)**
The Hydrophilic coating minimizes moisture buildup on the fin.
- Complex Resin (Corrosion resistant)**
The Black coating provides strong protection from corrosion.
- Aluminum fin**

※ Verification of corrosion resistance performance
- Test Method B of ISO 21207
- ASTM B117 / ISO 9227 (10,000 hours)



R1 Compressor™

R1 Compressor is one that combines high-efficiency, low sound characteristics of the scroll and the simple compressing structure of the rotary compressor. This technology enables a highly efficient compact model.

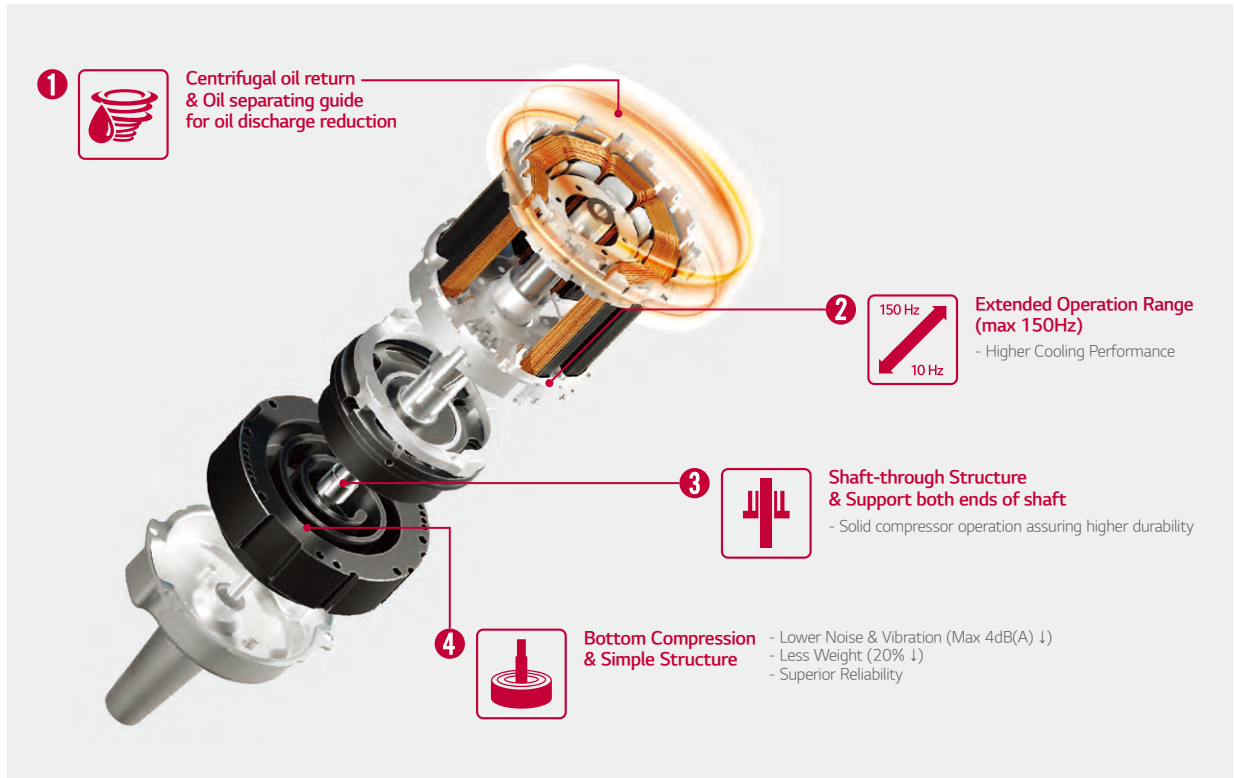

Conventional Compressor

Scroll : High efficiency / Low sound

(Continuous compression, but complex structure)

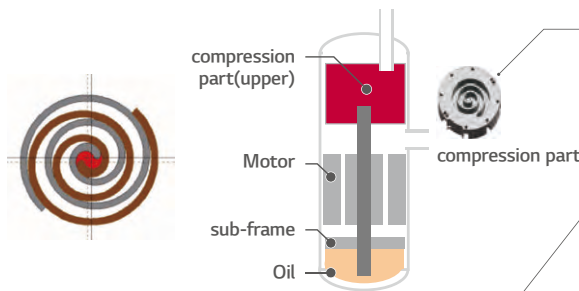

Rotary : Simple structure

(Compression per 1 rotation)

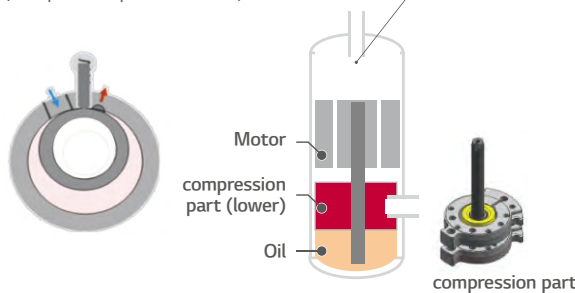

R1 Compressor™

Revolutionary Scroll : High efficiency / Stable & Simple Structure

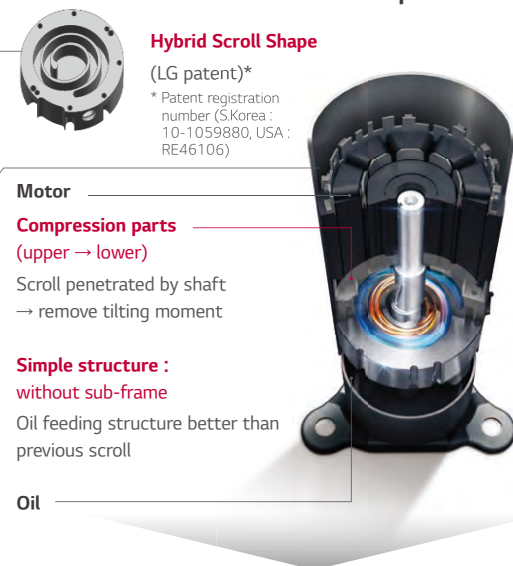

Extended operation (Max 150Hz)
Low noise & Vibration (Max 4dB(A) ↓)
Less weight (20% ↓)

Compact model

(Size 40% ↓, Weight 25% ↓)



